

ZOOMAX[®]

LUNA S

Handheld Video Magnifier

User Manual

V1.0

ZOOMAX Technology Co., Limited

9F, Building D, Paradise Software Park, No.3 Xidoumen Road, Xihu District, Hangzhou, China 310012

Copyright© 2021 ZOOMAX Technology Co., Limited.
All Rights Reserved.

ZOOMAX® is a trademark of ZOOMAX Technology Co., Limited in the United States and other countries. Information in this document is subject to change without notice. No part of this publication may be reproduced or transmitted in any forms or by any means, electronic or mechanical, for any purpose, without the express written permission of ZOOMAX.

USER MANUAL

1. Introduction.....	1
2. What's in the Box	1
3. General Description	2
4. Battery	3
4.1. Charge the Battery	3
4.2. Power Saving	3
5. Basic Operation.....	4
5.1. Power on	4
5.2. Adjust Magnification.....	4
5.3. Change the Color Mode	5
5.4. Freeze Image	6
6. Advanced Functions	7
6.1. FM Radio.....	7
6.2. Flashlight Mode	7
6.3. Rotate the Image.....	8
6.4. Voice Control	8
7. Settings	11
7.1. Beep Sounds	11
7.2. Camera Light	11
7.3. Screen Brightness	12
7.4. Memory Function	12
7.5. Factory Reset Function	12





8. Other Information	13
8.1. Install the Battery.....	13
8.2. Install the Short Strap	13
8.3. Writing Stand	13
9. Troubleshooting	14
10. Safety and Maintenance	15
11. Specifications	16

1. Introduction

The Zoomax® Luna S is a modern, lightweight handheld video magnifier with a 4.3 inch widescreen TFT display. It provides both basic video magnifier functions (up to 19x magnification, 10 high contrast colors, etc.) and advanced functions such as FM radio and voice control (available in specific countries/regions).

2. What's in the Box

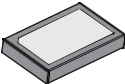
You will find the following items inside the Luna S package box:

 <p>Video magnifier</p>	 <p>Short strap</p>
 <p>User manual</p>	 <p>Rechargeable lithium-ion battery</p>
 <p>Protective case</p>	 <p>AC power adapter</p>

3. General Description

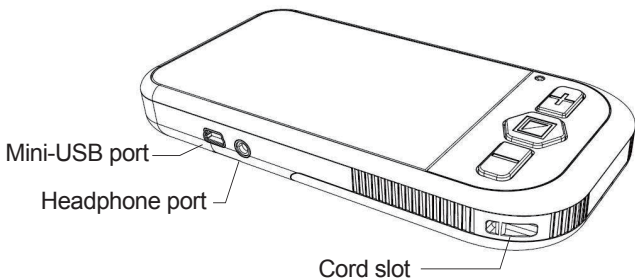
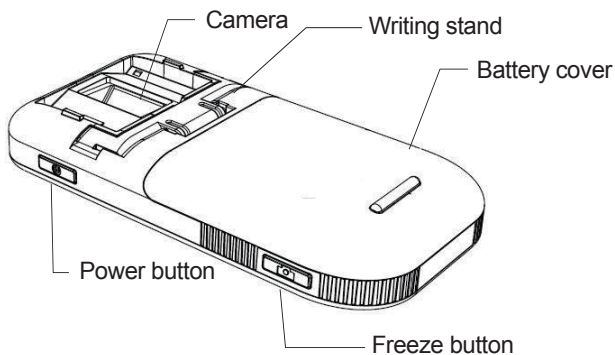
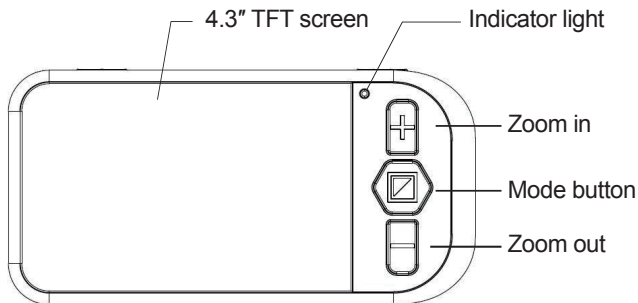

4. Battery

4.1. Charge the Battery

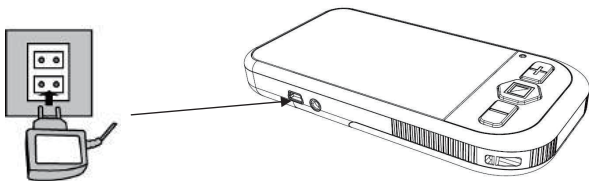

Note: please make sure the battery is charged before using the Luna S for the first time.

Charging Instructions

- 1) Plug the end of AC power adapter into an electrical socket.
- 2) Attach the adapter cable to the Luna S via Mini-USB port.
- 3) The indicator will light red during the charging time.
- 4) When the battery is fully charged, the indicator will turn green if the unit is on, or turn off if the unit is off.
- 5) If the "low battery" icon appears on the screen, it indicates that the battery is low and the machine will shut down soon.

The charging time of Luna S is 4 hours. A fully charged battery will last for approximately 3 hours. You can purchase an extra battery for long trips or extended use.

4.2. Power Saving

To save the power, Luna S will shut down automatically after 3 minutes of inactivity.

5. Basic Operation

5.1. Power on

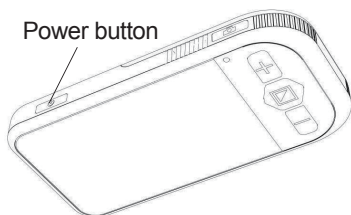

Press and hold the Power button for 3 seconds to turn the unit on. The power indicator will light green. You can turn the device off in the same way.

5.2. Adjust Magnification

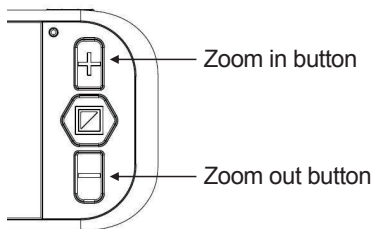

Press the Zoom in button to zoom in, and press the Zoom out button to zoom out.

Magnification levels:

- The magnification is from 3.8x to 19x if Luna S is placed flat on the paper.
- The lowest magnification will change to 2x if Luna S is used with open writing stand.

5.3. Change the Color Mode

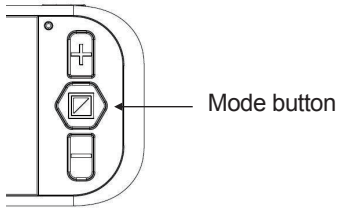

You can choose between the normal mode and favorite/simplified mode:

Normal Mode

In Normal mode, press the Mode button to cycle through the following viewing modes:

- True color mode
- Grayscale
- High contrast modes, including:
 - White on black/black on white
 - White on blue/blue on white
 - Yellow on black/black on yellow
 - Blue on yellow/yellow on blue

Favorite/simplified Mode

In this mode, press the Mode button to cycle through 3 color modes: true color, your favorite high contrast color and its reverse (such as white on blue & blue on white). To enter favorite mode, choose your favorite contrast color in normal mode, and then press and hold the Mode button for 3 seconds until you hear two beeps. The chosen color mode will be your favorite color mode.

Note: If the unit enters favorite mode from true color mode or grayscale instead of a high contrast color, the switch will be among true color, white on black and black on white.

To exit favorite mode, press and hold the Mode button for 3 seconds until you hear two beeps again.

5.4. Freeze Image

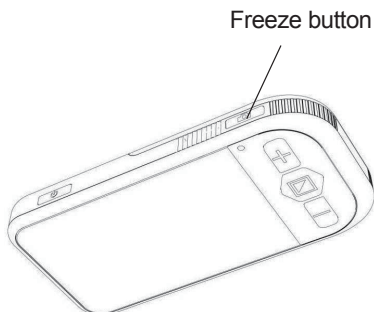

Use the Freeze function to capture images and letters, so that you can lift the unit up to take a closer look.

- 1) Put the unit over the object or material.
- 2) Press the Freeze button, and the image will be frozen.
- 3) You can now take the unit up and bring it closer to you to see the details of the image.
- 4) Press the Zoom in or Zoom out buttons to zoom in/out the image, or press the Mode button to change the color mode.
- 5) Press the Freeze button again to go back to the real-time view.

6. Advanced Functions

6.1. FM Radio

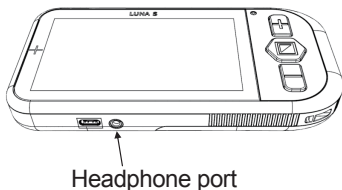

Luna S enables you to listen to FM radio. With an earphone or headphone*, you can enjoy your favorite local radio station.

To enter FM radio function, hold the Freeze button and the Mode button simultaneously until the radio  appears on the screen. You can exit the FM radio the same way.

Press the Zoom in or Zoom out buttons to switch among the radio channels.

To adjust volume, press the Freeze button to increase volume, or the Mode button to decrease it.

* Earphone or headphone with 3.5mm (1/8") plug.

6.2. Flashlight Mode

The flashlight mode enables you to use Luna S as a handy flashlight.

Short press the Power button to enter the flashlight mode. When the flashlight mode is on, the screen will turn off, and other functions will be inactive too.

To exit, short press the Power button again. The screen of Luna S will be on again once the flashlight mode is off.

6.3. Rotate the Image

When the frozen image is in the lowest magnification, press and hold the Zoom out button for 2 seconds to rotate the image 180°. You can rotate it back the same way.

6.4. Voice Control*

Voice control is a unique function of Luna S that facilitates the hands-free use. To activate the voice control function, speak out "Hi, Luna". A text prompt "Voice function is on, please speak" will show up on the screen. Then, with a few voice commands, you will be able to use Luna S easily.

The voice function will be automatically turned off after 1 minute of no voice command. A text prompt "Voice function is off and inactive" will appear on the screen when it is inactivated.

* Voice control is available in specific countries/regions only.

Voice Control Functions

- Zoom in/Zoom out:

Speak out "big"/"small", and the image will zoom in/out by one level. The command works in both real-time view and frozen view.

- Change the Color Mode

Speak out "color", and the color mode will change just like when the Mode button is pressed. In any color mode, speak out the color mode name (e.g. "true color" or "black white"), and the color mode will automatically change to the one specified.

- Freeze Image

When you use the real-time view, speak out "photo", and the display will be frozen. Speak out "photo off", and the display will be back to the real-time view.

- FM Radio

When you use the real-time view, speak out "radio", and the FM radio will be activated. Speak out "radio off" to exit FM radio mode.

- Flashlight Mode

Speak out "light on" to activate the flashlight mode. Speak out "light off" to deactivate the flashlight mode.

- Power off

Speak out "power off" to turn Luna S off in 3 seconds.

Voice Commands

For detailed instructions, please refer to the following table:

Voice Command	Function
Hi Luna	Activate the Voice control
Power off	Turn off the Luna S
Big	Zoom in
Small	Zoom out
Photo	Freeze the image
Photo off	Go back to the viewing mode
Radio	Turn on the radio
Radio off	Turn off the radio
Light on	Turn on the flashlight mode
Light off	Exit the flashlight mode
Color	Change color mode
True color	Change the color mode to true color

Black white	Change the color mode to white on black
White black	Change the color mode to black on white
Blue white	Change the color mode to white on blue
White blue	Change the color mode to blue on white
Black yellow	Change the color mode to yellow on black
Yellow black	Change the color mode to black on yellow
Yellow blue	Change the color mode to blue on yellow
Blue yellow	Change the color mode to yellow on blue

7. Settings

7.1. Beep Sounds

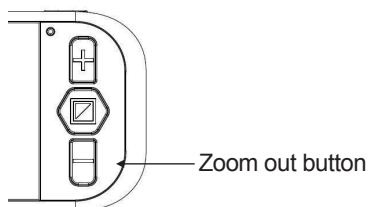

By default, the button beep sound is on.

To turn it off, press and hold the Zoom out button for 5 seconds until you hear one beep sound.

To turn it on again, press and hold the Zoom out button for 5 seconds again until you hear three beep sounds.

7.2. Camera Light

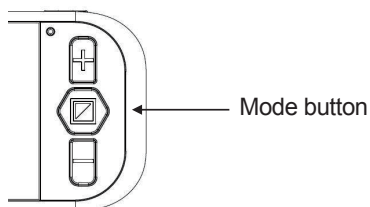

The camera light is on by default.

To turn the light off, press and hold the Mode button for 5 seconds until you hear three beep sounds. You can turn the light on the same way.

Note: there will be one beep sound before the final three beeps. Please keep holding the Mode button until the light changes.

7.3. Screen Brightness

Short press the Freeze button and the Zoom in (or Zoom out) button simultaneously to enter brightness adjustment and a brightness bar will appear.

Press the Zoom in button to increase brightness, and the Zoom out button to decrease.

Press the Mode button to confirm the brightness and exit, or leave it for 5 seconds until the brightness bar disappears. The adjusted brightness will be saved automatically.

7.4. Memory Function

The Luna S will automatically keep the most recent settings on the next power-on (e.g. color mode, magnification, button beeps, brightness, etc.).

7.5. Factory Reset Function

In the lowest magnification, simultaneously press Power button and Zoom out button for 10 seconds to restore to the original factory settings.

8. Other Information

8.1. Install the Battery

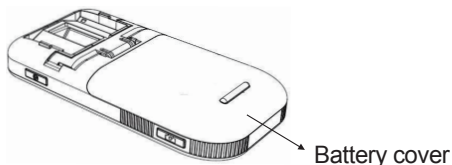

- 1) Turn the unit over.
- 2) Slightly press the battery cover, and slide it to open.
- 3) Insert the battery. Make sure the holes on the battery match the pins in the battery compartment.
- 4) Place the cover back and slide it into the closed position.

8.2. Install the Short Strap



Take the short strap, insert the small loop through the cord slot in the bottom right corner of Luna S. Thread the other end of the strap through the loop and pull the end tight.

8.3. Writing Stand

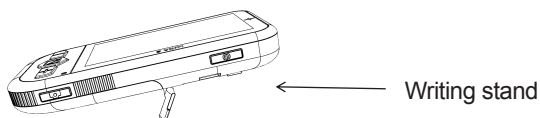

Open the writing stand, and you will be able to write underneath the camera easily, like signing a bill or taking some notes.

9. Troubleshooting

Problems	Solutions
Black screen	<ol style="list-style-type: none">1. Ensure that the power is on.2. Change the battery.3. Reduce the magnification level.4. Ensure the image is below the crosshair.
The unit does not turn on.	Charge the unit.
The image on the screen is dark or distorted.	Ensure the video magnifier is flat on the page.
Power adapter is connected but the battery is not charging.	Ensure the outlet has power and the plug is fully inserted in the power jack.
Smudges or blemishes on the screen.	Clean camera and screen with soft cloth.
Text is too small to read.	Adjust the magnification up to a suitable level.
Text is too large to read.	Adjust the magnification down to a suitable level.
The screen is frozen or distorted or any other problem not mentioned in this manual.	Restart the unit or remove and replace battery.

If your problem is not listed above, please contact your local distributor.

10. Safety and Maintenance

To maintain Luna S in optimal condition:

- To avoid risk of fire, do not expose Luna S to excessive heat or direct sunlight.
- To avoid the risk of electrical damage, keep Luna S away from fluids and chemicals.
- To avoid the risk of electrical shock, do not attempt to disassemble the unit. Please refer service requests to Zoomax or an authorized repair facility.
- Always unplug the Luna S before cleaning. Use a cleaning cloth or a soft damp cloth to clean the exterior. Do not use cleaning agents or abrasive material, as they will damage your video magnifier.
- The use of a screen protector might influence the functioning of the touch screen.
- Use the Luna S in environments where the temperature is between 10°C and 40°C (50°F and 104°F).

11. Specifications

- Magnification: 2x to 19x
- Display modes: True color, grayscale, and 10 high contrast color modes
- Focus: Auto focus
- Screen: 4.3 inch widescreen TFT
- Flashlight mode: Yes
- FM radio: Yes
- Voice control: Available in specific countries and regions
- Power saving: Unit will turn off automatically after no activity for 3 minutes
- Battery: Rechargeable lithium-ion battery
- Battery life: 3 hours continuous use
- Charging time: 4 hours
- Power adapter:
Input: 110 - 240V
Output: 5V/1A
- Weight: 7 oz / 200g with battery, 5.9 oz / 167g without battery
- Dimensions: 16cm x 8cm x 2.4cm / 6.3" x 3.15" x 0.94"
- Operation and storage conditions:
Humidity < 70%
Temperature: 10-40°C

ZOOMAX TECHNOLOGY CO., LIMITED

9F, Building D, Paradise Software Park,
No.3 Xidoumen Road, Xihu District, Hangzhou
Zhejiang 310012, China

Tel: +86-571-87006308

Fax: +86-571-87397220

Email: support@zoomax.com

Visit us at www.zoomax.com

ZOOMAX[®]

Zoom Your Vision, Max Your Life